

# **Proton dose calculation algorithms and configuration data**

Barbara Schaffner

PTCOG 46 – Educational workshop in Wanjie, 20. May 2007

# Agenda

---

- Broad beam algorithms
- Concept of pencil beam dose calculation
- Beam configuration data for Eclipse Proton
- CT calibration

# Agenda

---

- **Broad beam algorithms**
- Concept of pencil beam dose calculation
- Beam configuration data for Eclipse Proton
- CT calibration

# Broad beam algorithm - Concept

---

- Find the range and the modulation of the beam required to cover the target
- Find the depth and the distance to the aperture for each point of interest (POI)
- Use look-up tables for the dose in depth and apply a correction for the lateral penumbra

# Broad beam algorithm - Concept

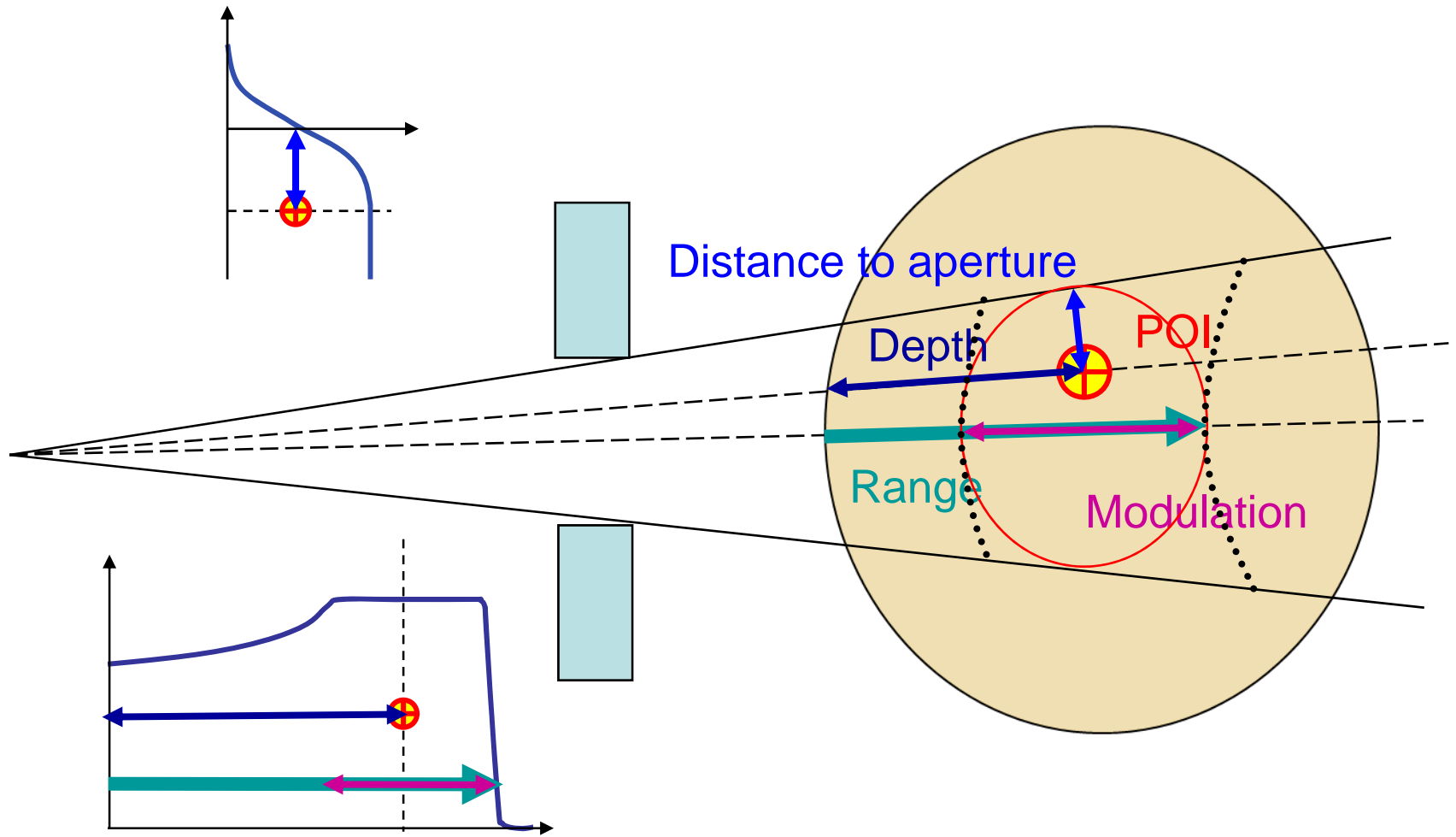

# Broad beam algorithm - Applications

---

- First proton dose calculation algorithms
- Used today only for ocular applications
  - Very fast algorithm
  - Loss in accuracy is small due to homogeneous tissues

# Agenda

---

- Broad beam algorithms
- **Concept of pencil beam dose calculation**
- Beam configuration data for Eclipse Proton
- CT calibration

# Eclipse pencil beam algorithm - Concept

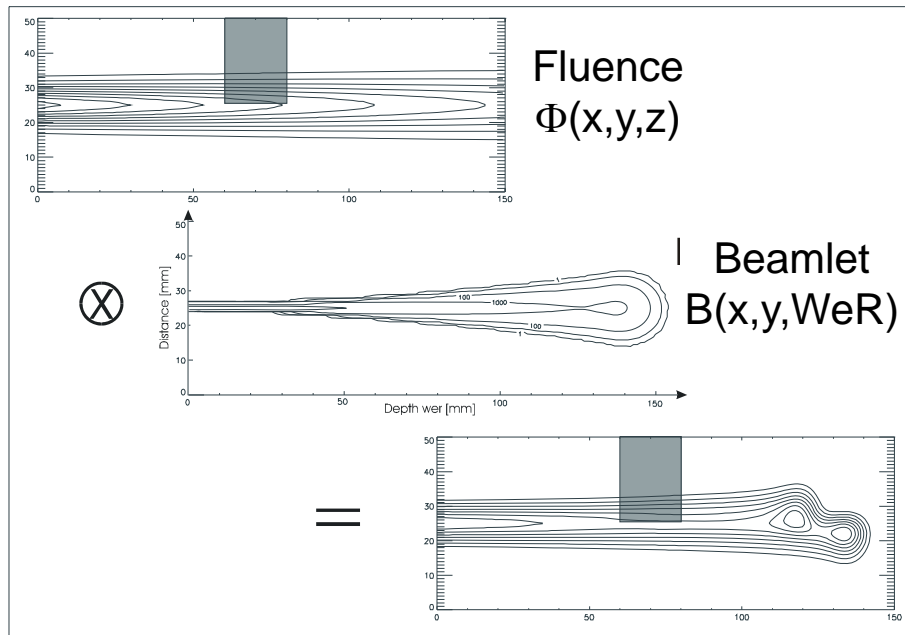

- Principle
  - Convolution of 3D undisturbed proton fluence in air with a 'beamlet' in water.
- In practice
  - Superposition of inhomogeneity - corrected beamlets and multiplication with fluence at calculation position.



# Fluence of a double scattering beam line

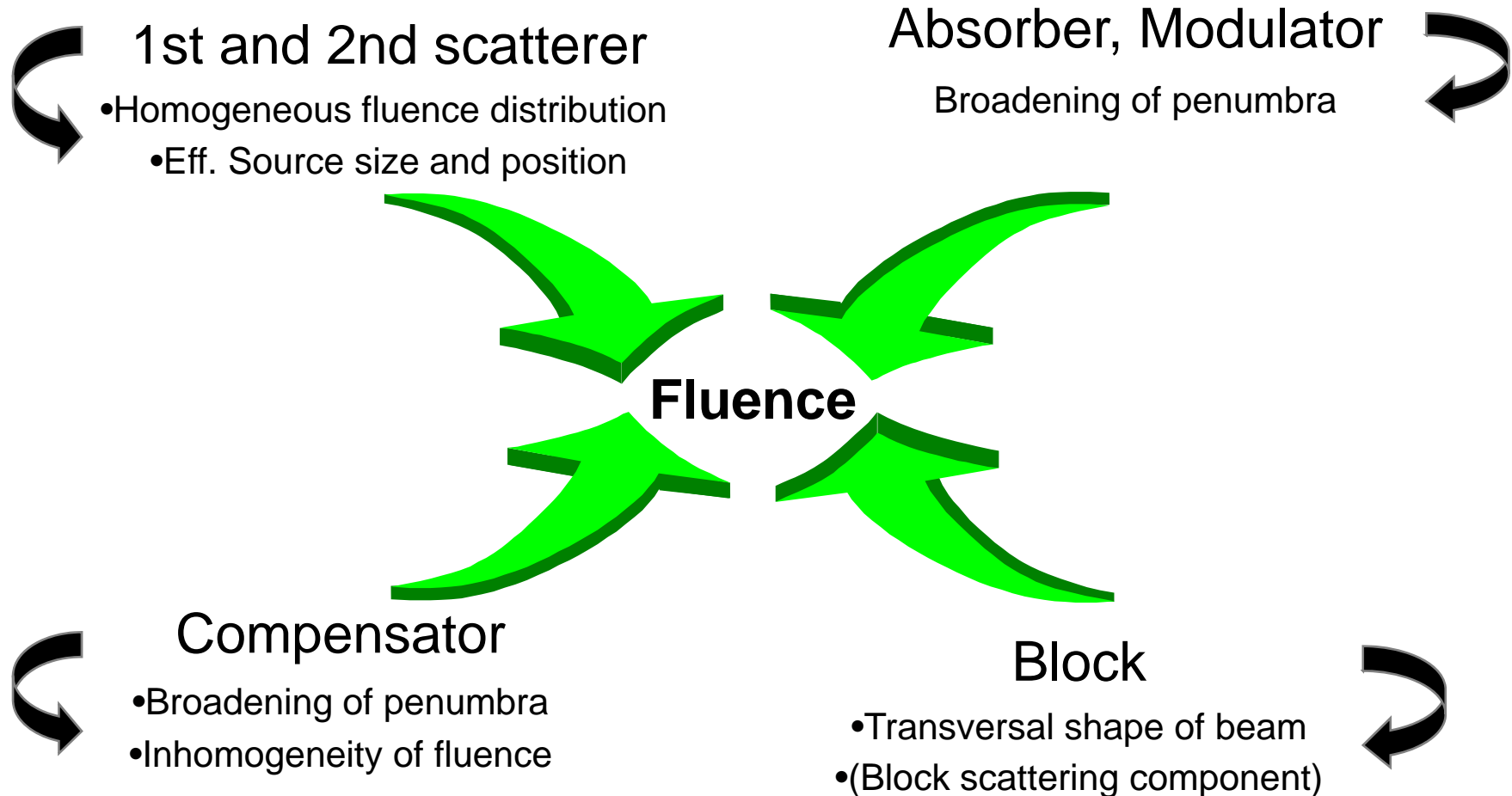

# Example of fluence distribution

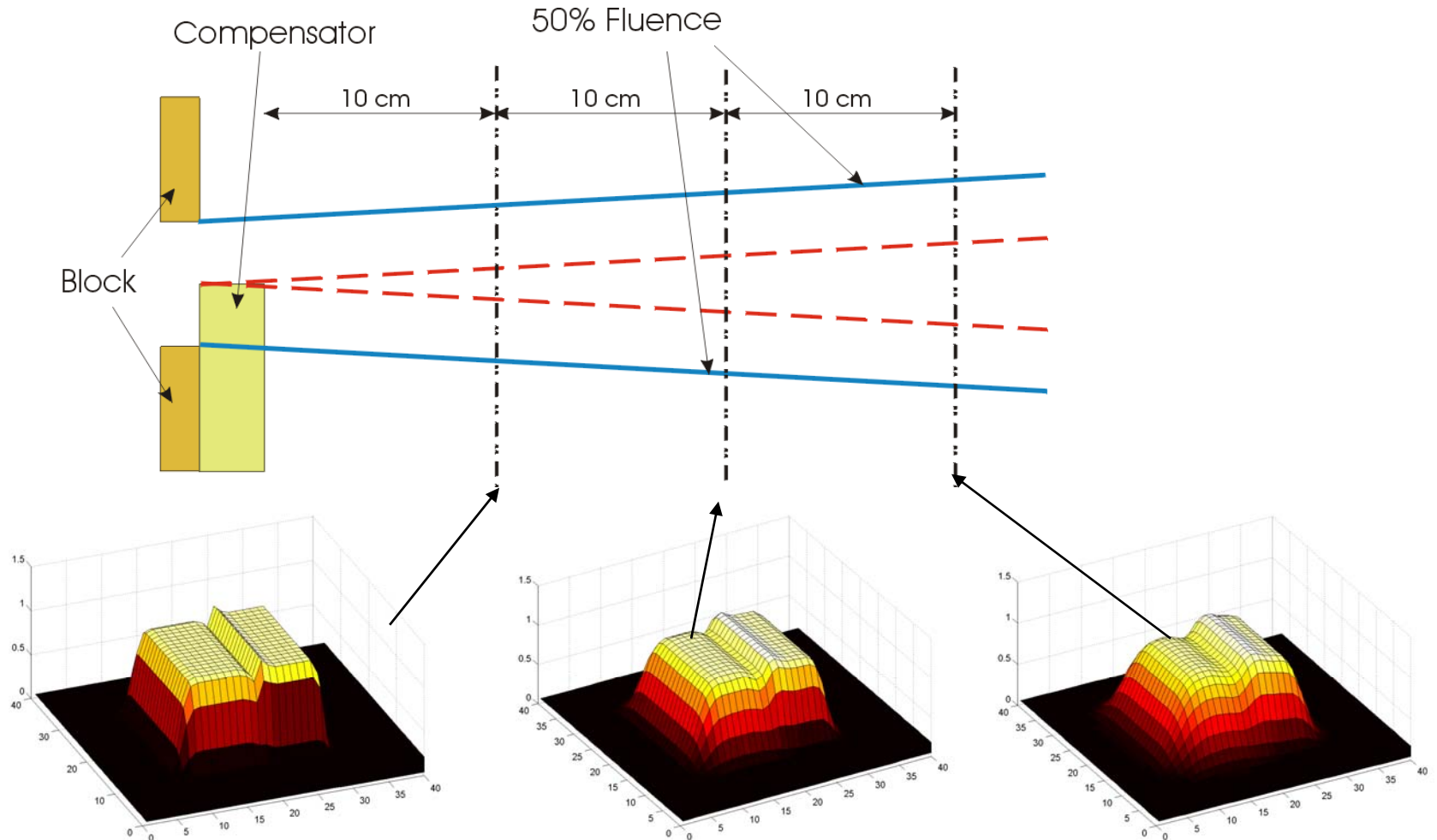

# Fluence of a scanning beam line

Phase space of single beam spot  
(Divergence, beam size at reference position)

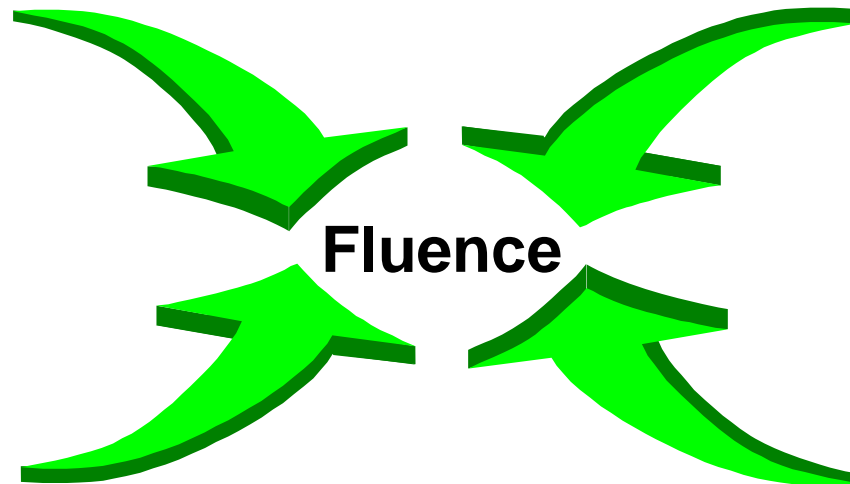

Scan pattern and weights of individual beam spots

# Example of scanning fluence distribution

Fluence of single pencil beam

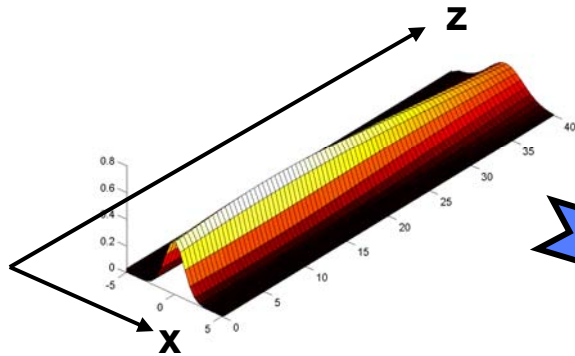

Scan pattern and weights

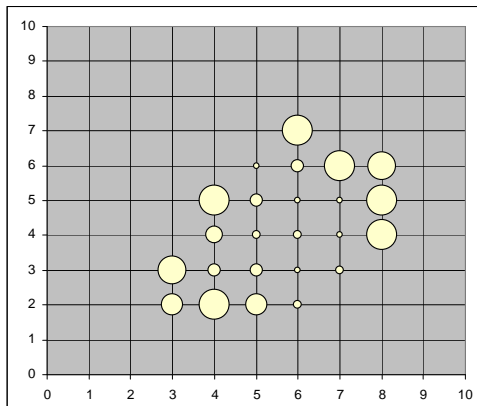

Total fluence

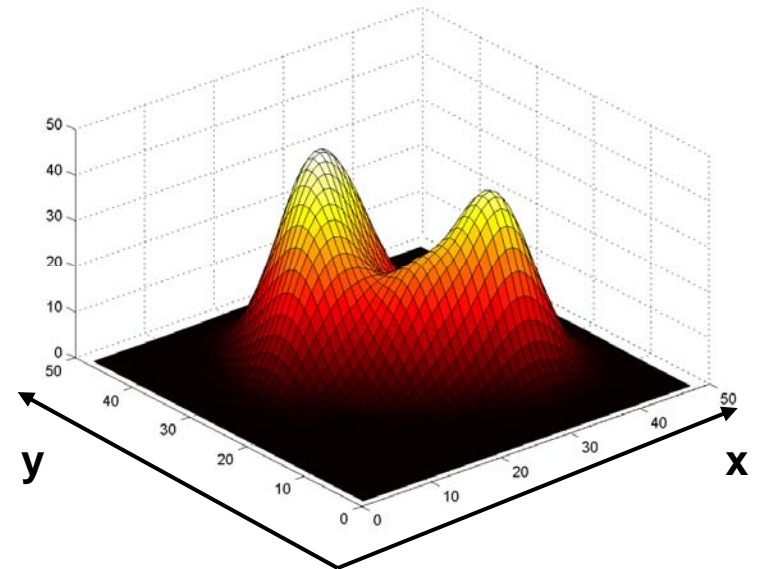

# Beamlet in water

---

- Definition:
  - Dose deposited by a proton beam, which hits a water surface without lateral extension and without angular divergence or confusion.
- Characterization:
  - Depth dose distribution
  - Transversal distribution
  - **Independant of technique!**

# Model of beamlet in water

---

- Model is based on analytical functions fitted to Monte Carlo calculated depth dose distributions
- Depth dose and scattering distributions are modeled for primary and secondary protons separately
- Measured depth dose curves are used to extract beam-line specific parameters for the model

# Example of calculated depth dose distribution

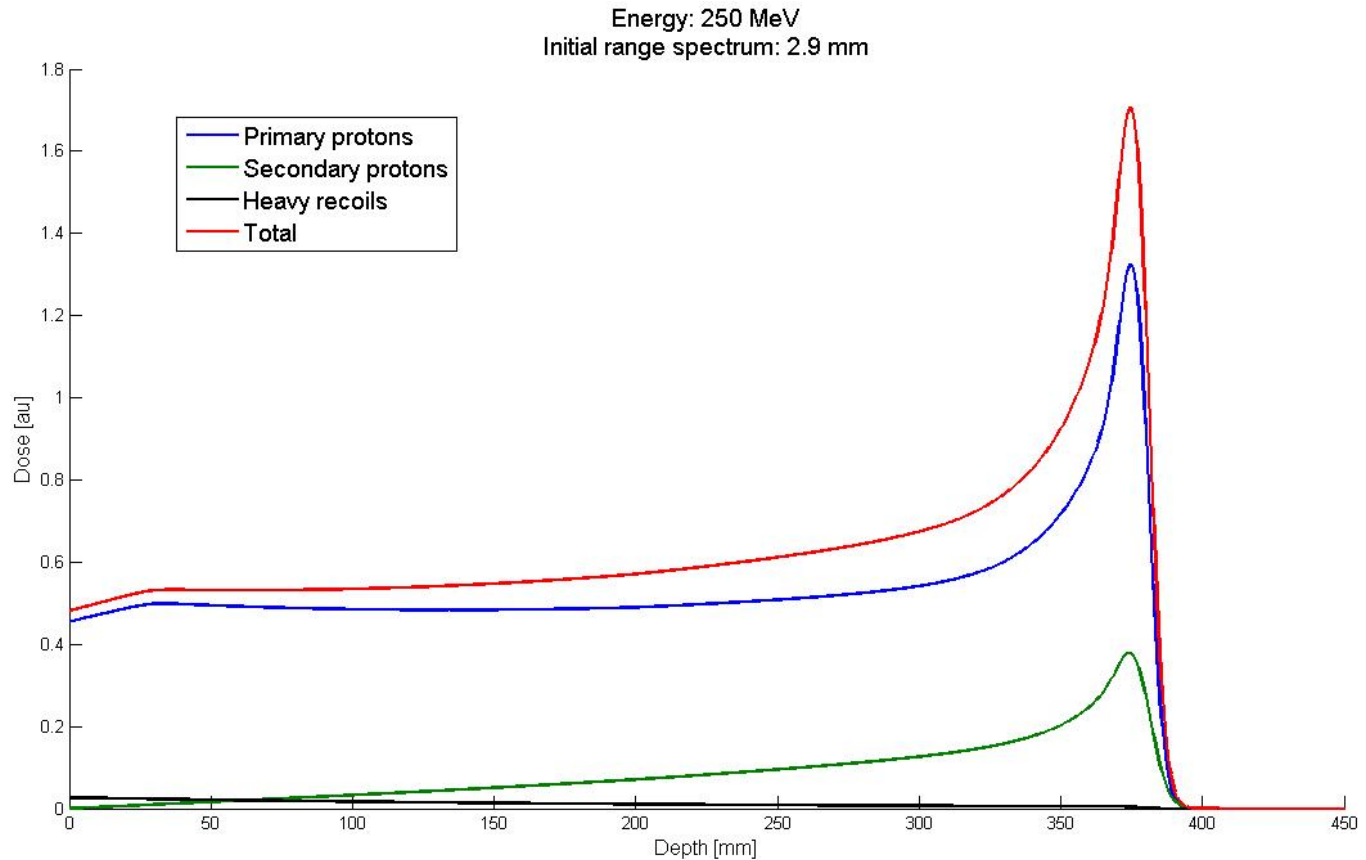

# Transversal distribution

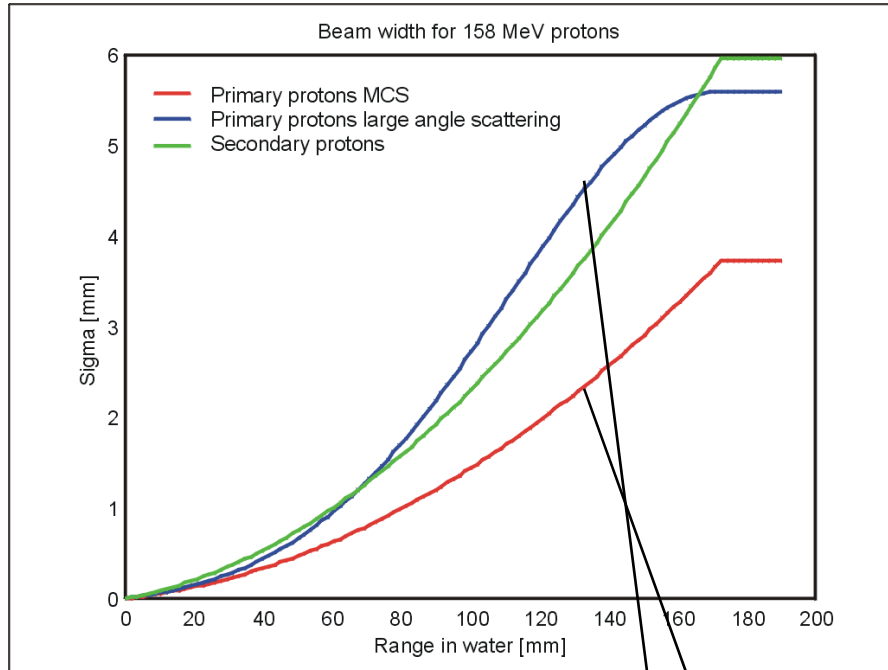

Beamlet transversal distribution at each position in depth is calculated from the sigma of one or several Gaussians.

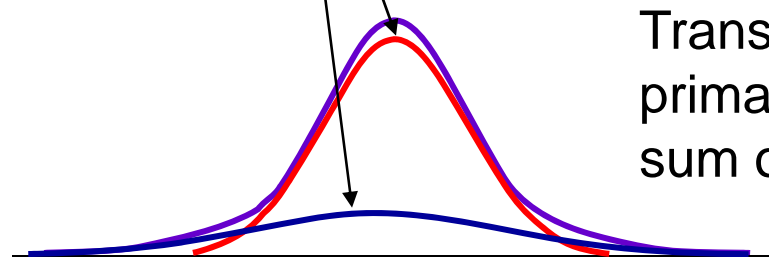

Transversal distribution of primary protons = sum of two Gaussians



# Inhomogeneity correction

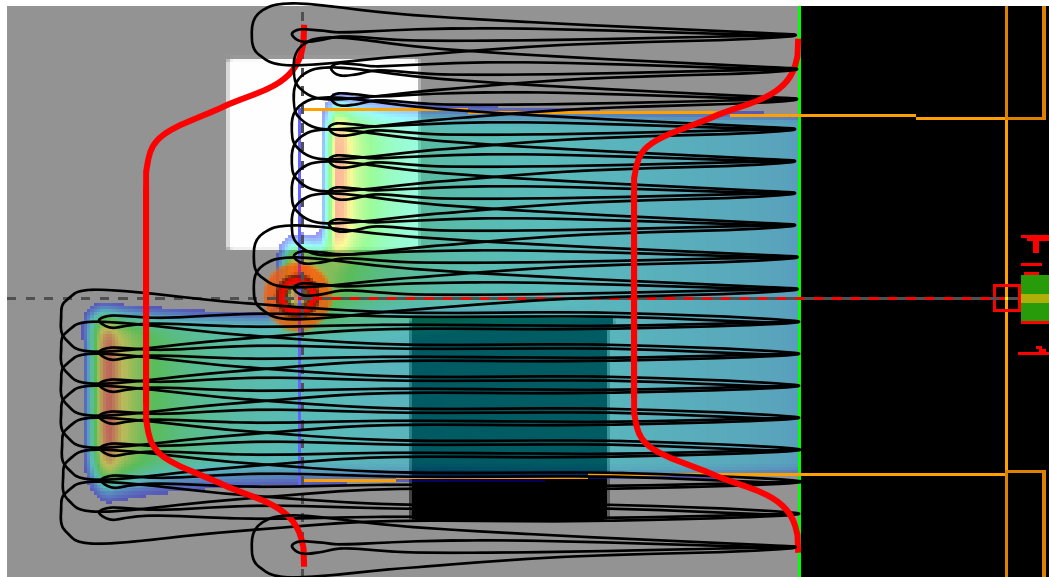

- Each beamlet is corrected for density variations before it is multiplied with the proton fluence in air

# Total SOBP dose

- Contributions of all layers are added in a final step.

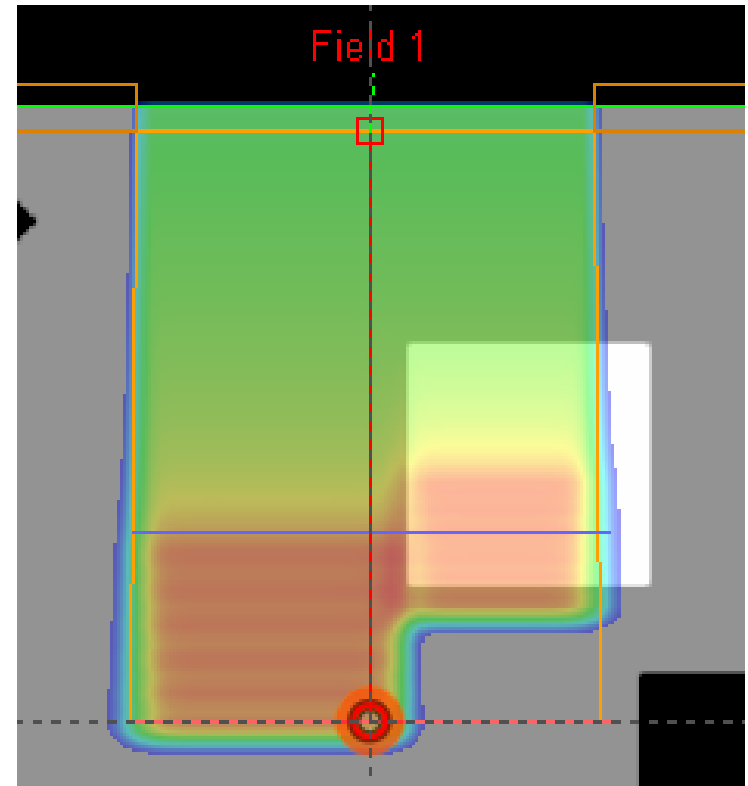

# Agenda

---

- Broad beam algorithms
- Concept of pencil beam dose calculation
- **Beam configuration data for Eclipse Proton**
- CT calibration

# Measurements – the input for the dose model

- Fluence calculation
  - Open field cross profiles -> Virtual SAD
  - Fluence along Z axis -> Effective SAD
  - Half beam block -> Lateral penumbra of fluence
  - Cross profiles of spot fluence -> Phase space
- Beamlet calculation
  - Depth dose curve -> Depth dose parameters

# Virtual SAD Calculation

- The virtual SAD is the ,geometric' SAD
- It is found by a linear fit to the field sizes measured at different positions along the beam axis

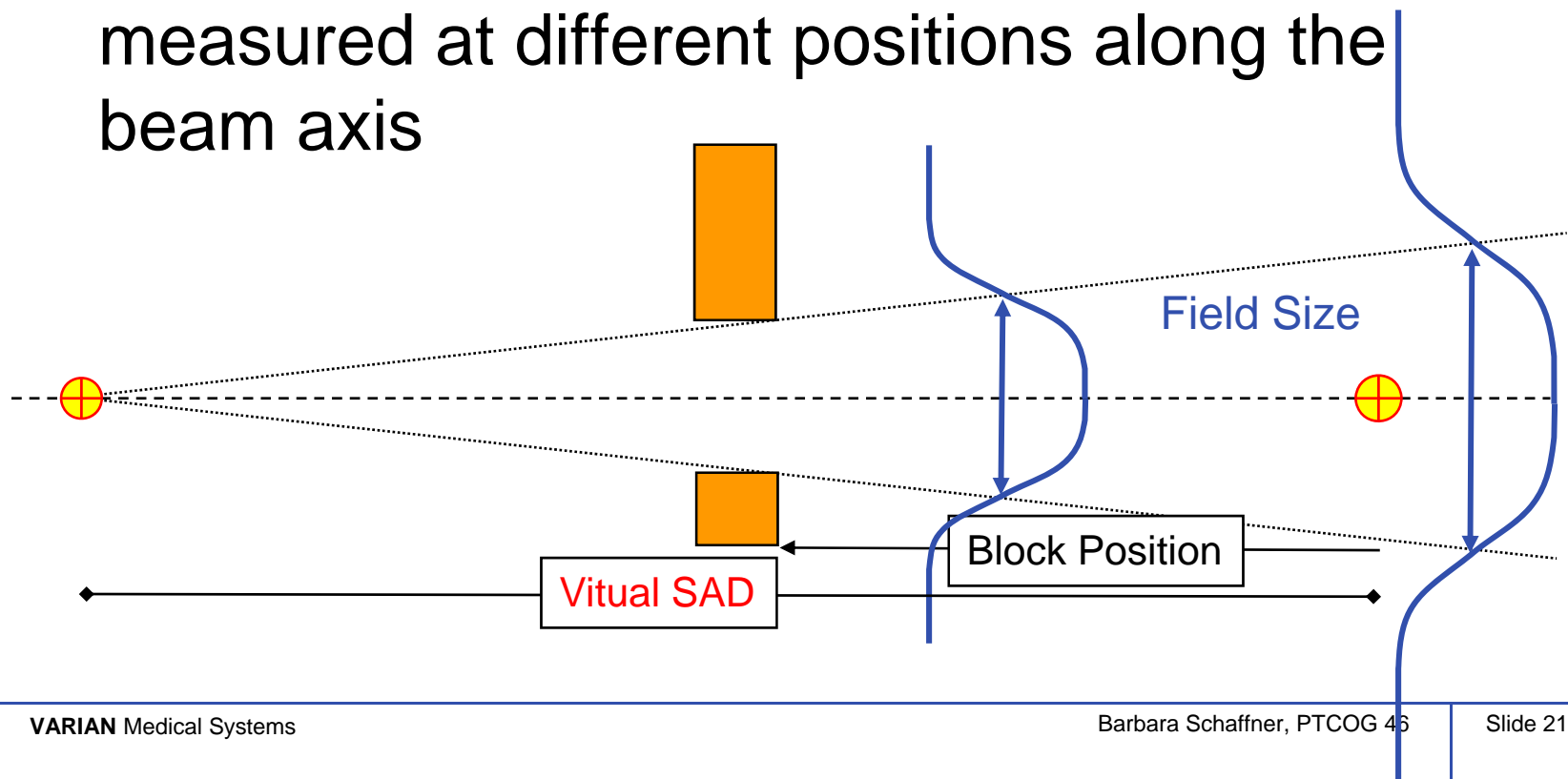

# Effective SAD Calculation

- The effective SAD is the ,dosimetric‘ SAD
- It is found by a  $1/r^2$  fit to the measurements of the fluence along the beam direction

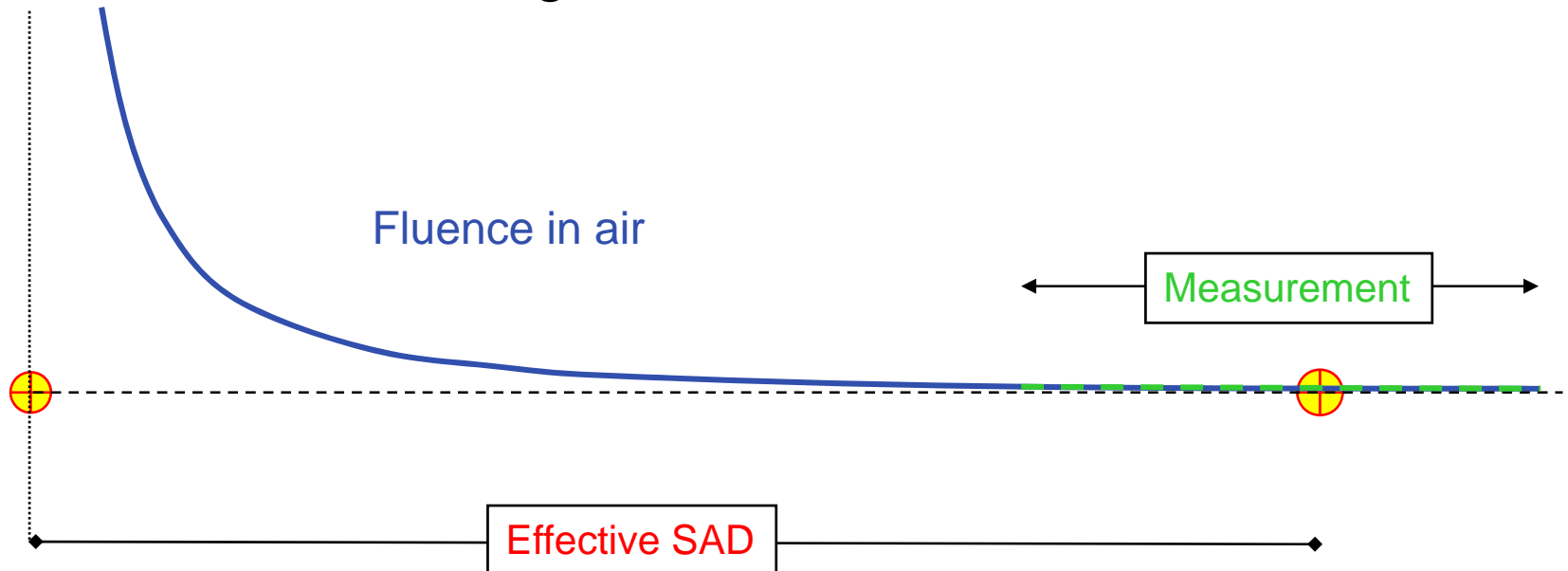

# Effective Source Size Calculation

- It is assumed that the penumbra shape can be modelled by the effective source size concept introduced by Hong et al.
- The proton source is assumed to be located at the position of the nominal source and to have a Gaussian distribution.

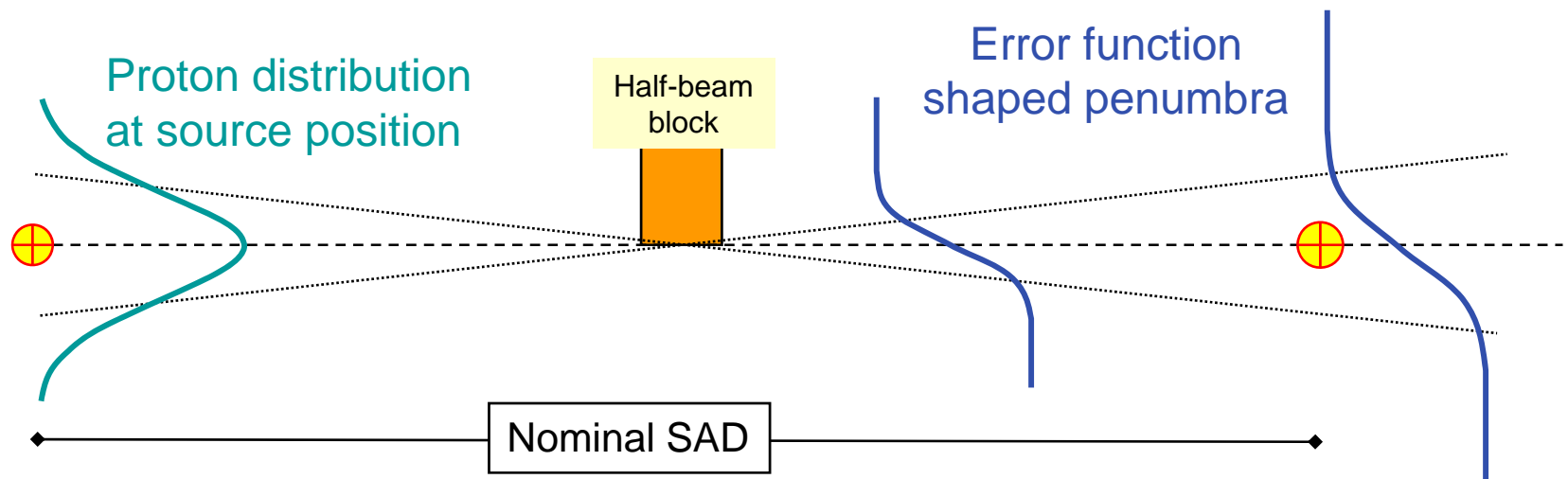

# Phase Space Parameters

- Phase space parameters are extracted from cross profile measurements of the spot fluence in air.
- The following formula is fitted to the spot size plotted as a function of the distance from isocenter:

$$f(z) = \sqrt{\frac{A}{2} + B \cdot z + \frac{C}{2} \cdot z^2}$$

Parabola with A, B,  
C parameters

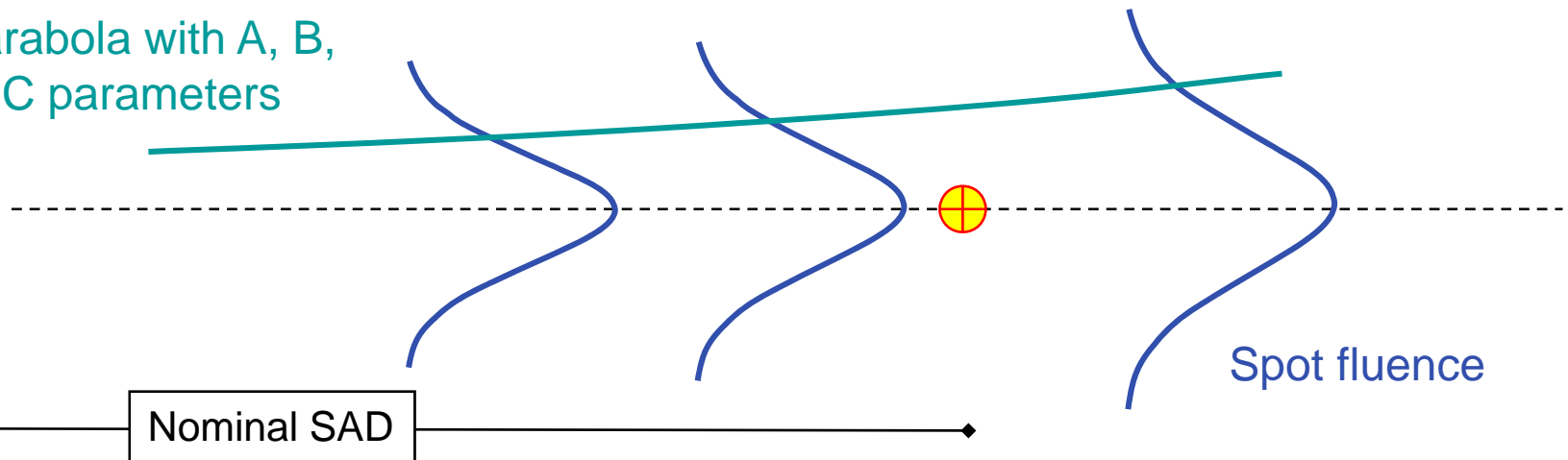



# Preprocessing of measured depth dose

- Measured depth dose gets shifted in depth by water equivalent thickness of the beamline
- Measured depth dose is corrected for intensity loss due to  $1/r^2$  effect

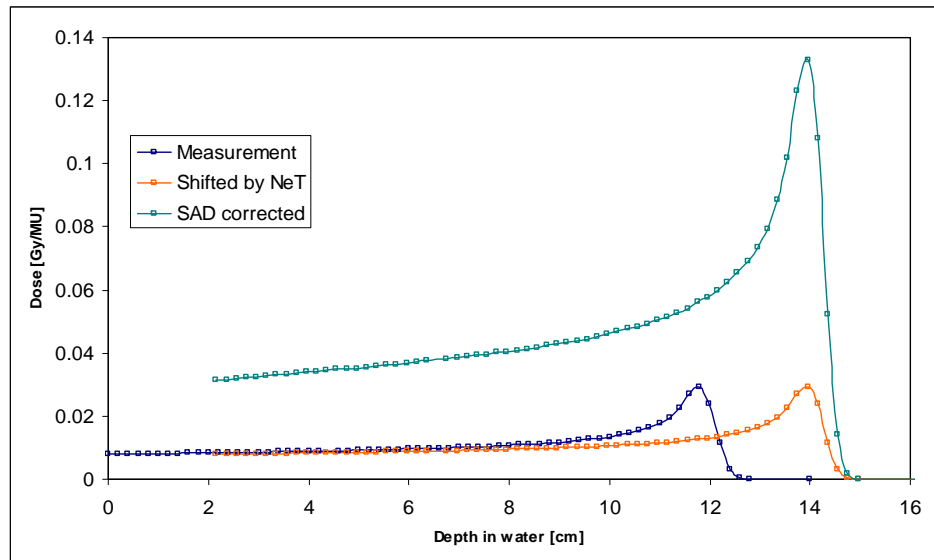

# Calculation of Depth Dose Parameters

- Resulting depth dose is used for a least square fit of analytic depth dose formula with free parameters

- Energy
- Spectral distribution  $\Sigma$
- Normalization
- Fraction of secondary protons (optional)

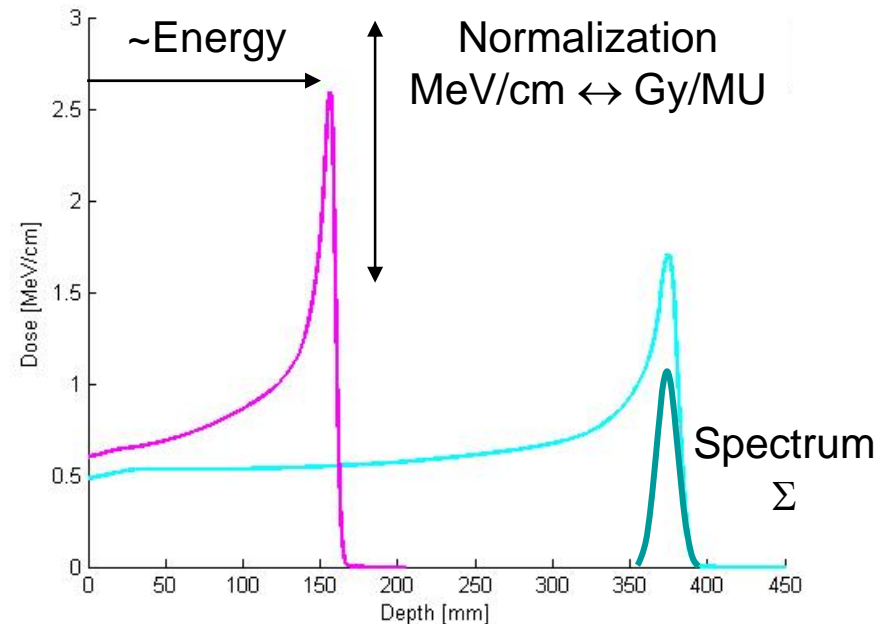

# Parametrization vs. LUTs

- Parametrization
  - Requires an analytical model for measured data. Failure of the model leads to bad dose calculation results
  - Allows interpolation (extrapolation) for situations other than the measured one (e.g. intermediate energy)
  - Smooths or averages results from measurements
- LUT (Look up table)
  - Measured curve can have an arbitrary shape
  - Difficult to interpolate, almost impossible to extrapolate
  - Needs some processing of measurements to smooth uncertainties

# Parametrization vs. LUTs – Example 1

## ■ Depth dose

160 MeV Depth dose

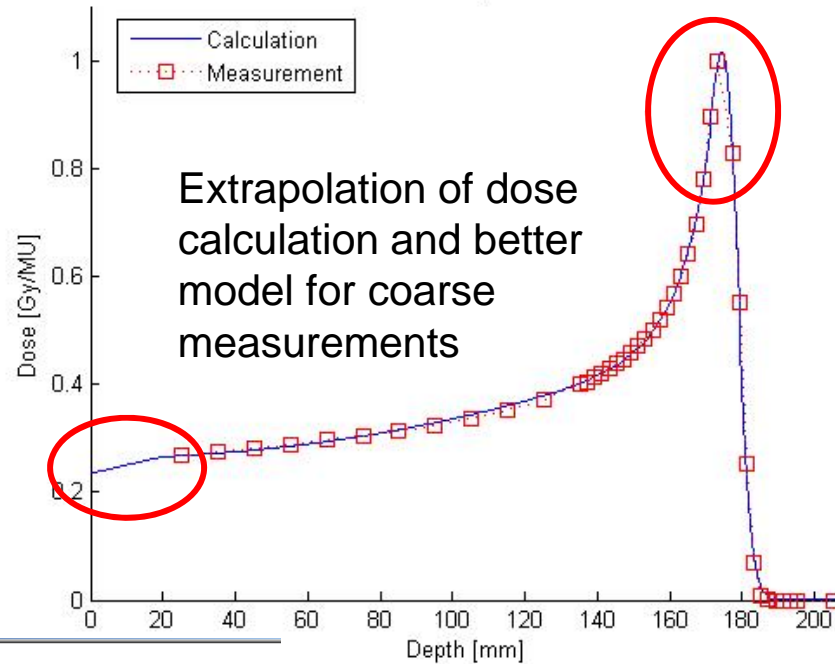

Interpolation of calibration factor for different energies

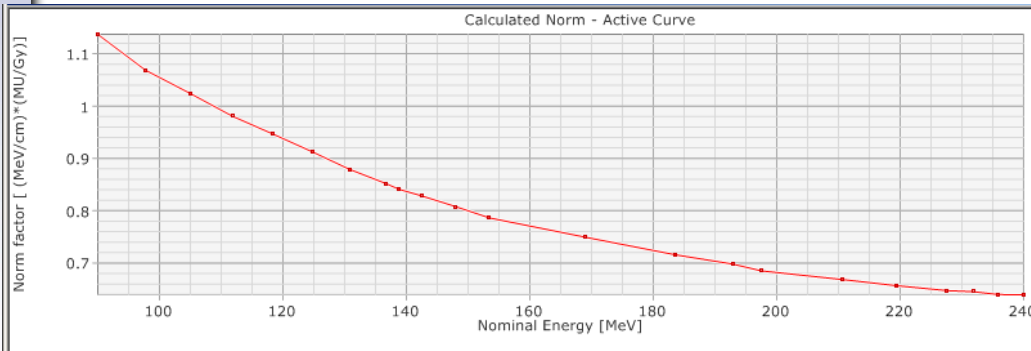

# Parametrization vs. LUTs – Example 2

- A-Parameter ( $= 2 \cdot \text{spot size at isocenter}^2$ ) for a scanning beam

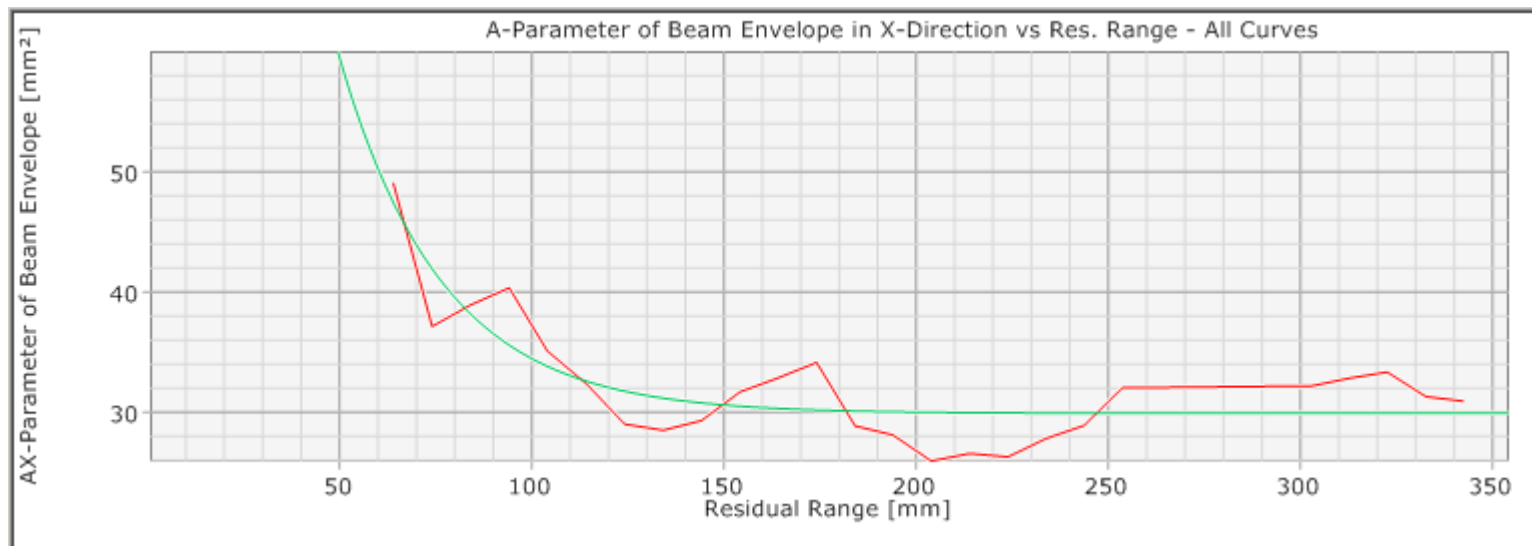

- ➡ Note: User must know, whether observed behavior of spot size is due to measurement uncertainties or other effects.

# Agenda

---

- Broad beam algorithms
- Concept of pencil beam dose calculation
- Beam configuration data for Eclipse Proton
- **CT calibration**

# Why CT calibration?

- CT scanners measure Hounsfield units defined as

$$HU = 1000 \frac{\mu_{\text{water}} - \mu_{\text{material}}}{\mu_{\text{water}}}$$

- Hounsfield units are a measure for the attenuation of an X-ray beam
- Hounsfield units **cannot** be used directly to calculate the behavior of proton or even high energy photon beams

# Definitions

- **Scaled HU:**  $HU_{sc} = HU + 1000$
- Absolute stopping power (SP) :  $-dE/dx$  [MeV/cm]
- Absolute mass SP :  $-(1/\rho)dE/dx$  [MeV/(g/cm<sup>2</sup>)]
- **Relative SP :** Ratio between abs. SP for material and water
- Relative mass SP : Ratio between abs. mass SP for material and water
- CT calibration: LUT for conversion between HU and relative SP



# Importance of accurate CT calibration

---

- A few percent error in the CT calibration causes a few percent shift of the dose in depth
- Due to the high distal gradient of the dose, this may lead to 100% difference in dose!
- ➡ Note: The calibration curve is sensitive to the X-ray spectrum of the CT scanner. It is important, that each scanner is calibrated individually.

# The stoichiometric CT calibration method

- Scan tissue equivalent samples of well known composition individually in the center of a water phantom
- Obtain parameters for  $HU_{sc}$  calculation by fitting results to HU-formula
- Calculate  $(HU_{sc}, SP_{rel})$  pairs for real tissue compositions
- Define calculation curve to follow calculated  $(HU_{sc}, SP_{rel})$  pairs for real tissue compositions

# Properties of the stoichiometric CT calibration method

---

- Scanner specific due to the use of reference measurements
- Uses a simplified, empirical theory for the calculation of Hounsfield units
- Yields good results for commonly used scanner energies of approx. 80 keV and biological tissue

# Calculation of ( $HU_{sc}$ , $SP_{rel}$ ) reference data pairs

- Calculation of  $HU_{sc}$  and  $SP_{rel}$  pair based on literature data for tissue composition
- $HU_{sc} = C_{mat} \left\{ K^{ph} \tilde{Z}^{3.62} + K^{coh} \tilde{Z}^{1.86} + K^{KN} \right\}$  **Don't use for MV CT!**
  - $K^{xy}$  parameterize the response of the scanner. They are determined by fitting the above formula to  $HU_{sc}$ -values measured on samples of well known chemical composition
- $SP_{rel}$  calculated with Bethe-Bloch formula

# Plot of calculated $(HU_{sc}, SP_{rel})$ pairs and linear fits

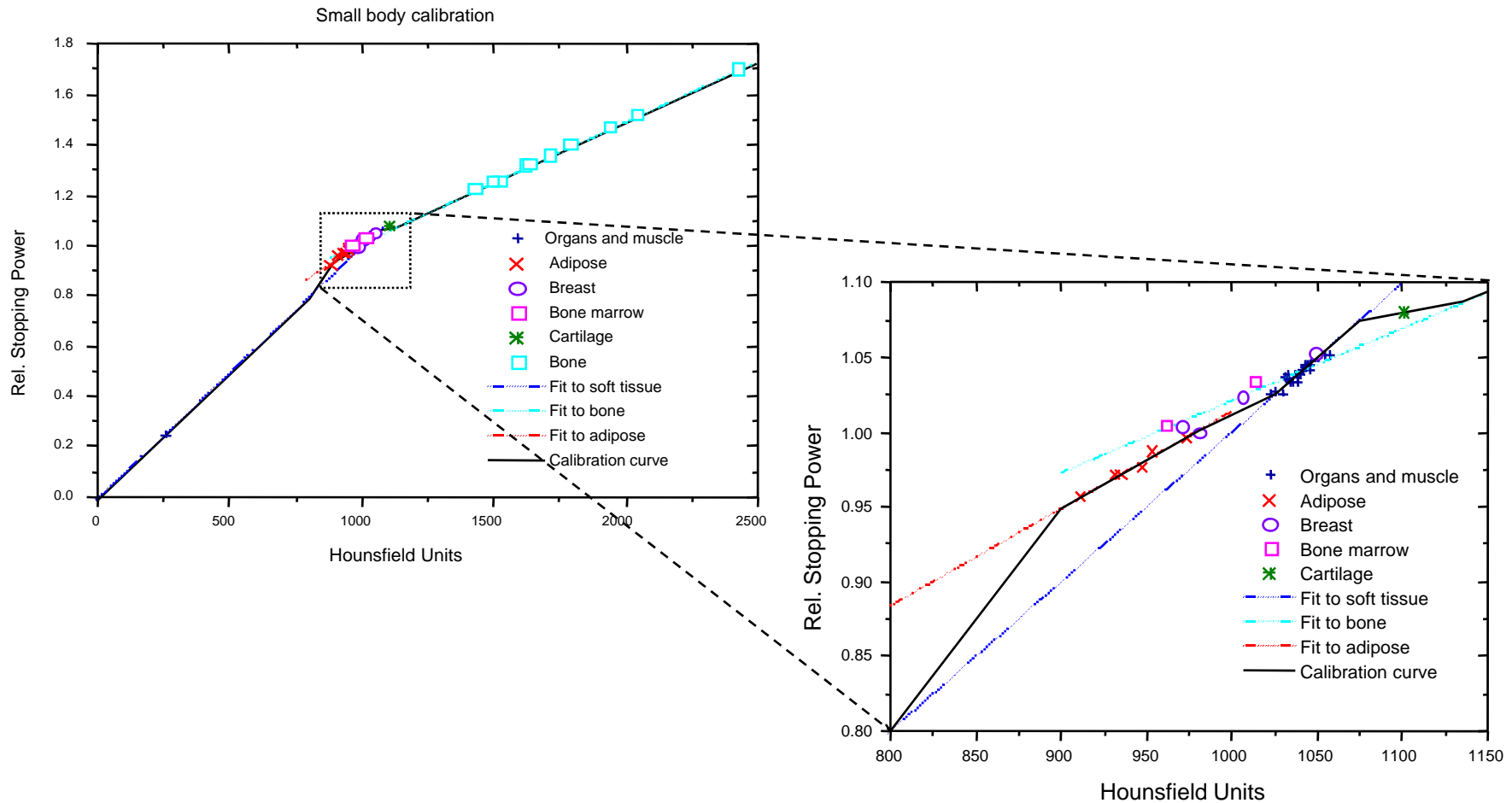

# Some references for further reading

---

- Schneider U, Pedroni E, Lomax A 1996 The calibration of CT Hounsfield units for radiotherapy treatment planning *Phys. Med. Biol.* **41** 111-124
- Schaffner B, Pedroni E 1998 The precision of proton range calculations in proton radiotherapy treatment planning: experimental verification of the relation between CT-HU and proton stopping power *Phys. Med. Biol.* **43** 1579-92
- Kanematsu N et al. 2003 A CT calibration method based on the polybinary tissue model for radiotherapy treatment planning *Phys. Med. Biol.* **48** 1053-64
- Schneider U et al. 2005 Patient specific optimization of the relation between CT-Hounsfield units and proton stopping power with proton radiography *Med. Phys.* **32(1)** 195-9



**Thank you for your interest  
and attention**